

Green *line*

UKINOX

katalog proizvoda



Green-line d.o.o. je preduzeće koje se bavi uvozom i distribucijom okova za nameštaj renomiranih svetskih proizvođača, osnovano 2000. godine. U okviru preduzeća posluju: maloprodaja u Jagodini i maloprodaja i veleprodaja sa sedištem u Nišu.

U našem prodajnom asortimanu nalazi se kompletan program vodećih svetskih brendova kao što su: FGV, Volpato, Poliplast, Rodi, Telma, Eurokant, Arkopa, Mekappa, Ukinox, System Furniture Accessories... Zahvaljujući dugogodišnjoj saradnji sa ino-dobavljačima u prilici smo da Vam ponudimo širok asortiman robe po najpristupačnijim cenama, veliki lager, kvalitetnu uslugu i naravno transport robe.

Ono na čemu insistiramo je pre svega kvalitet proizvoda i trudićemo se da, zajedno sa Vama, narednih godina pratimo sve svetske trendove i unesemo kvalitet u Vaš dom.

Tržište je preplavljeno proizvodima različitih robnih marki, kvaliteta i cena, tako da pažljivo i stručno birajući kao za sebe, odabrali smo najbolje za Vas.

U očekivanju da ćete postati naš stalni partner, sa najboljim željama, Green line d.o.o.



"Ukinox Kuhinjski Sistemi" je kompanija osnovana 1992. u Istanbulu, Turska. Od osnivanja prve fabrike, proizvodi sudopere od nerđajućeg čelika najvišeg kvaliteta, sa najnaprednijim nivoom ekspertize u industriji. Poseduju sertifikate internacionalnih organizacija standarda, kao što su BE EN ISO 9001, CE i UPC.

U poslednje dve dekade izvozi svoje kuhinjske sisteme širokog spektra na selektivna tržišta sveta, uključujući Evropu i Severnu Ameriku.

Cilj Ukinox-a je da postane Vaš izbor za visokokvalitetne sudopere superiornog dizajna, vrednosti, sa velikom pažnjom posvećenom i najsitnijim detaljima.

sadržaj

serija Comfort	7
serija Lotus	15
serija Wind	19
serija D	19
serija Grand	21
serija Galant	23
serija Compact	25
serija Favorite	27
serija Standard	33
Dodatna oprema	39



sudopere >
by UKINOX

Nerđajući čelik

Nerđajući čelik koji se koristi u našoj proizvodnji je AISI 304 BA ili BA Lajnen 18-10 cr/ni.

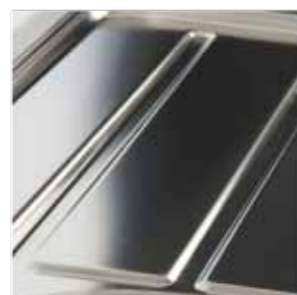

Polirani



Mat (Saten)



Lajnen (površina sa teksturom)

Instalacija sudopere

Molimo Vas da obratite pažnju tokom dostave i instalacije vaših sudopera. U slučaju zidne montaže, ostavite minimum 25mm rastojanja od zida. Ovo rastojanje je naročito potrebno kod kamenih i mermernih ploča. U tom slučaju, 60mm prostora će biti izdvojeno između bazena sudopere i zida ostavljajući rupu na sredini niže police u kuhinji. Izbegavajte upotrebu automatskog pištolja za povezivanje metalnih delova i zatezanja delova za odvod, jer time možete napraviti stalna oštećenja na vašem proizvodu.

Pažnja! Možete videti upozorenja/ ograničenja za svaki model sudopere dok pravite otvore na policama.

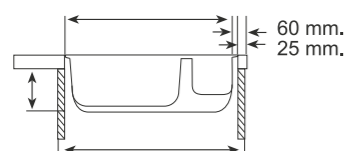

Ugradna sudopera



Podgradna sudopera



Nasadna sudopera



Instalacija sudopere i uputstvo za upotrebu

Uputstvo za održavanje površine nerđajućeg čelika

Ukinox sudopere su proizvedene od visokokvalitetnog nerđajućeg čelika (hrom/nikl 18-10). Nerđajući čelik zadržava svoj fini i čisti izgled ako se uputstva za održavanje pravilno primenjuju.

Nakon upotrebe sudopere, prebrišite mrlje od vode i ponovo isperite vodom. Zatim osušite površinu sa čistom krpom trljajući. Upotrebljavajte periodično pastu za čelik koja se koristi specijalno za ovakve površine. Nakon čišćenja površine sa pastom koja se nanosi mekom krpom ili sunderom, isperite sa dosta vode i osušite.

Sve kiseline, rešenja sa upotrebom soli, sredstva na čišćenje na bazi srebra i lepila za tapete ostavljaju mrlje nakon nekoliko sati. Ako ove supstance dođu u kontakt sa sudoperom, očistite i isperite površinu sa dosta vode i osušite.

Ne ostavljajte gvozdene elemente koji lako rđaju ili druge metalne materijale u sudoperi na duže vreme, jer površina može zarđati.

Puderi za čišćenje, tvrdi sunderi i četke mogu oštetiti površinu. Izbegavajte njihovu upotrebu!

Ogrebotine koje se pojavljuju tokom regularne upotrebe sudopere ne smanjuju kvalitet same sudopere. Tanki sloj oksida se formira na površini nerđajućeg čelika koja je štiti od moguće korozije i grebanja.

Nemojte čuvati hemikalije za čišćenje ispod sudopere zato što isparenja mogu oštetiti površinu nerđajućeg čelika.

Uputstvo za otklanjanje mrlja

Mrlja	Metod otklanjanja mrlje
Tvrđokorna prljavština Mrlje od ulja Mrlje od čaja ili kafe	Primenite bilo koji materijal za čišćenje koji se koristi za otklanjanje mrlja sa krpom ili sunderom, i isperite površinu sa toplom vodom. Možete koristiti sredstvo sa hlorinom da biste uklonili tvrdokornije mrlje bez dugotrajnog kontakta sa površinom.
Fleke na bazi soli i limunske kiseline	Koristite odstranjivač fleka ili primenite 25%/tni rastvor vinskog sirćeta da se rešite suvih fleka. Ostavite da stoji 1 minut, očistite površinu sa puno vode i onda je osušite.
Mrlje od rđe	U slučaju mrlja od rđe na površini sudopere nastalih upotrebom gvozdениh činija i tiganja, možete koristiti tečnost za pranje nakita i vrednih materijala. Ipak, ovakvi tipovi hemikalija poliraju površinu i ostavljaju mrlje, tako da morate obratiti pažnju na sledeća pravila: 1. Ne koristite ovaj tip hemikalije vrlo često i oprezno trljajte površinu gde se nalazi mrlja. 2. Ako koristite sudoperu sa panelima ili sudoperu montiranu odozgo čistite površinu dužinski. Unutrašnjost sudopere čistite kružnim pokretima.





www.green-line.com

CO 381.381 GT



CO*480.480 GT



CO*580.488



CO*594.488.15 GT



CO*778.488 GT



CO*788.488 GW



CO*778.488.15 GT



CO* 972.492.15 GT



CO*776.507.15 GT



CO*776.507 GW



CO*780.476.20 GT

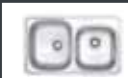

CO*1160.500.20 GT



serija Comfort >



Instalacione šeme



Ukupne dimenzije

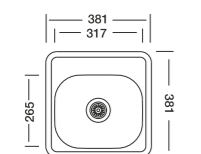

Dimenzija za ugradnju

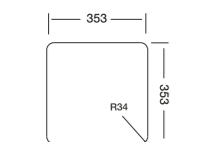

Širina korpusa

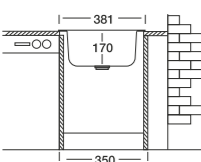

Šifra	Model	Obrada	Dubina korita	Lim deblj.	Slivnik
67.100.01	COM 381.381 GT 6K	mat	170 mm	0.6 mm	3 1/2

Dodatni pribor

808 CR



B 34.40



SBT 32.35



S-701 GT



S-700 T



S-905 P



S-905



Instalacione šeme



Ukupne dimenzije

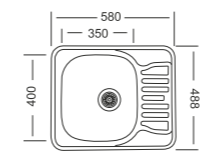

Dimenzija za ugradnju

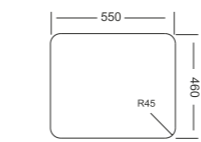

Širina korpusa

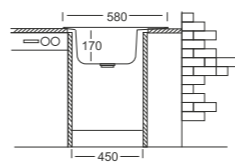

Šifra	Model	Obrada	Dubina korita	Lim deblj.	Slivnik
67.102.01	COM 580.488 GT 6K	mat	170mm	0.6mm	3 1/2

Dodatni pribor

808 CR



B 35.40



SBT 32.35



S-700 T



S-701 GT



S-905 P



S-905



Instalacione šeme



Ukupne dimenzije

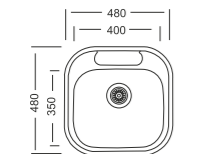

Dimenzija za ugradnju

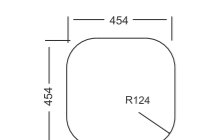

Širina korpusa

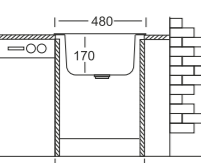

Šifra	Model	Obrada	Dubina korita	Lim deblj.	Slivnik
67.101.01	COM 480.480 GT 6K	mat	170 mm	0.6 mm	3 1/2
67.101.02	COL 480.480 GT 6K	linen	170 mm	0.6 mm	3 1/2

Dodatni pribor

808 CR



B 35.40



SBT 32.35



S-700 T



S-701 GT



S-905 P



S-905



Instalacione šeme



Ukupne dimenzije

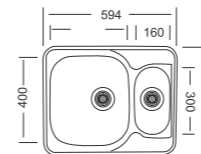

Dimenzija za ugradnju

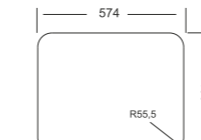

Širina korpusa

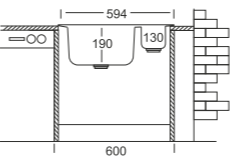

Šifra	Model	Obrada	Dubina korita	Lim deblj.	Slivnik
67.103.01	COP 594.488/15 GT 8K	polirana	190/130 mm	0.8 mm	3 1/2

Dodatni pribor

808 CR



CP 16.30



CS 16.30



B 35.40



SBT 32.35



S-805



S-805 P



Instalacione šeme



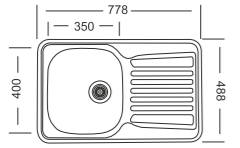

Ukupne dimenzije

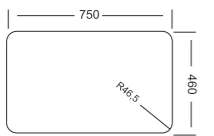

Dimenzija za ugradnju

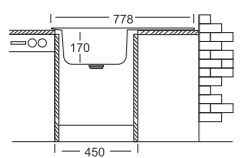

Širina korpusa





Šifra	Model	Obrada	Dubina korita	Lim deblj.	Slivnik
67.104.02	COL 778.488 GT 6K	linen	170 mm	0.6 mm	3 1/2

Dodatni pribor

- 808 CR
- B 35.40
- SBT 32.35
- S-701 GT
- S-700 T
- S-905 P
- S-905

Instalacione šeme



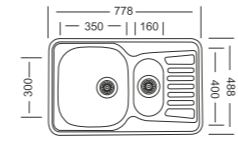

Ukupne dimenzije

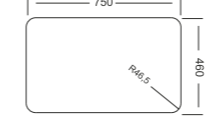

Dimenzija za ugradnju

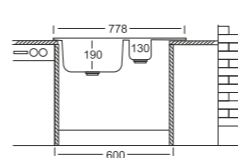

Širina korpusa





Šifra	Model	Obrada	Dubina korita	Lim deblj.	Slivnik
67.105.01	COP 778.488/15 GT 8K	polirana	190/130 mm	0.8 mm	3 1/2
67.105.02	COL 778.488/15 GT 8K	linen	190/130 mm	0.8mm	3 1/2

Dodatni pribor

- 808 CR
- CP 16.30
- CS 16.30
- B 35.40
- SBT 32.35
- S-805
- S-805 P

Instalacione šeme



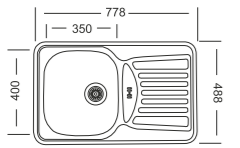

Ukupne dimenzije

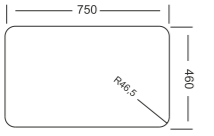

Dimenzija za ugradnju

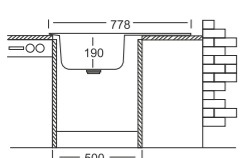

Širina korpusa

Šifra	Model	Obrada	Dubina korita	Lim deblj.	Slivnik
67.104.01	COP 778.488 GW 8K	polirana	190 mm	0.8 mm	3 1/2

Dodatni pribor

- 808 CR
- B 35.40
- SBT 32.35
- S-701 GW
- S-701 GWP
- S-905 P
- S-905

Instalacione šeme



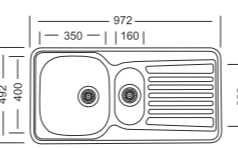

Ukupne dimenzije

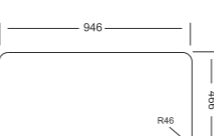

Dimenzija za ugradnju

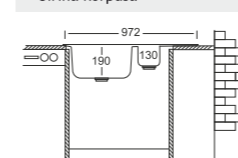

Širina korpusa

Šifra	Model	Obrada	Dubina korita	Lim deblj.	Slivnik
67.106.01	COP 972.492/15 GT 8K	polirana	190/130 mm	0.8 mm	3 1/2
67.106.02	COL 972.492/15 GT 8K	linen	190/130 mm	0.8mm	3 1/2

Dodatni pribor

- 808 CR
- CP 16.30
- CS 16.30
- B 35.40
- SBI 32.35
- S-805
- S-805 P

Instalacione šeme



Ukupne dimenzije

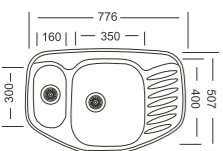

Dimenzija za ugradnju

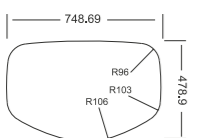

Širina korpusa

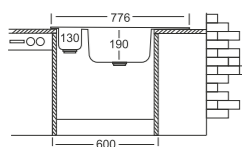

Šifra	Model	Obrada	Dubina korita	Lim deblj.	Slivnik
67.107.01	COP 776.507/15 GT 8K	polirana	190/130 mm	0.8 mm	3 1/2
67.107.02	COL 776.507/15 GT 8K	linen	190/130 mm	0.8 mm	3 1/2

Dodatni pribor

808 CR



CP 16.30



CS 16.30



B 35.40



SBT 32.35



S-805



S-805 P



Instalacione šeme



Ukupne dimenzije

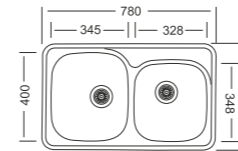

Dimenzija za ugradnju

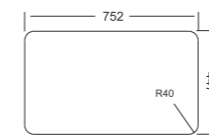

Širina korpusa

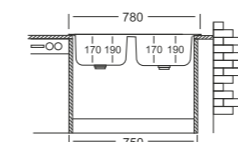

Šifra	Model	Obrada	Dubina korita	Lim deblj.	Slivnik
67.109.01	COM 780.476/20 GT 6K	mat	170/170 mm	0.6 mm	3 1/2
67.109.02	COL 780.476/20 GT 6K	linen	170/170 mm	0.6 mm	3 1/2
67.109.03	COP 780.476/20 GT 8K	polirana	190/190 mm	0.8 mm	3 1/2

Dodatni pribor

808 CR



B 34.40



SBT 32.35



S-805



S-805 P



Instalacione šeme



Ukupne dimenzije

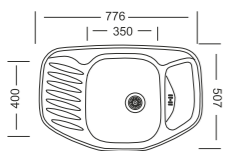

Dimenzija za ugradnju

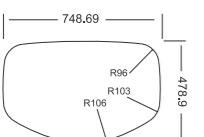

Širina korpusa

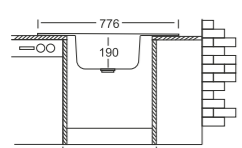

Šifra	Model	Obrada	Dubina korita	Lim deblj.	Slivnik
67.108.01	COP 776.507 GW 8K	polirana	190 mm	0.8 mm	3 1/2

Dodatni pribor

808 CR



B 35.40



SBI 32.35



S-701 GW



S-701 GWP



S-905 P



S-905



Instalacione šeme



Ukupne dimenzije

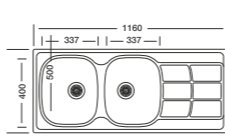

Dimenzija za ugradnju

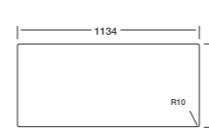

Širina korpusa

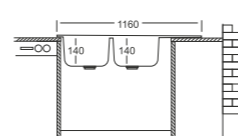

Šifra	Model	Obrada	Dubina korita	Lim deblj.	Slivnik
67.110.01	COM 1160.500/20 GT 6K	mat	140/140 mm	0.6 mm	3 1/2

Dodatni pribor

808 CR



B 34.40



SBT 32.35



S-805



S-805 P





Green line

LT*615.500 GT



LT*780.500 GT



LT*780.500.15 GT



LT*950.500.15 GT



LT*915.500 GT



serija Lotus >



Instalacione šeme



Ukupne dimenzije

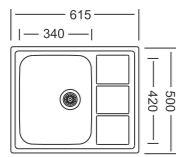

Dimenzija za ugradnju

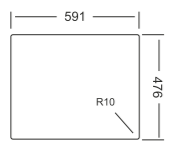

Širina korpusa

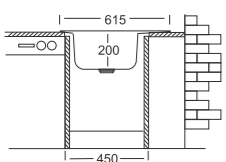

Šifra	Model	Obrada	Dubina korita	Lim deblj.	Slivnik
67.120.01	LTP 615.500 GT 8K	polirana	200 mm	0.8 mm	3 1/2

Dodatni pribor

B 34.42



SB 32.40



S-701 GT



S-701 GTP



S-905 P



S-905



Instalacione šeme



Ukupne dimenzije

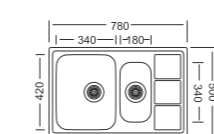

Dimenzija za ugradnju

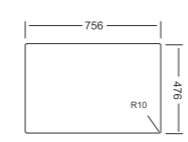

Širina korpusa

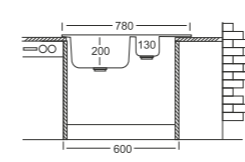

Šifra	Model	Obrada	Dubina korita	Lim deblj.	Slivnik
67.122.01	LTP 780.500/15 GT 8K	polirana	200/130 mm	0.8 mm	3 1/2

Dodatni pribor

808 CR



CS 18.34



B 34.42



SB 32.40



S-805



S-805 P



Instalacione šeme

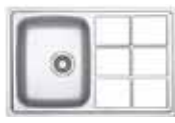

Ukupne dimenzije

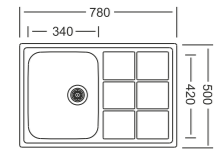

Dimenzija za ugradnju

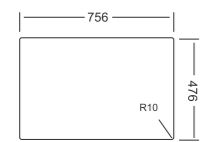

Širina korpusa

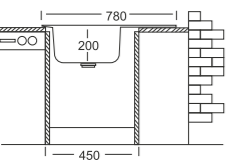

Šifra	Model	Obrada	Dubina korita	Lim deblj.	Slivnik
67.121.01	LTP 780.500 GT 8K	polirana	200 mm	0.8 mm	3 1/2

Dodatni pribor

B 34.42



SB 32.40



S-701 GT



S-701 GTP



S-905 P



S-905



Instalacione šeme



Ukupne dimenzije

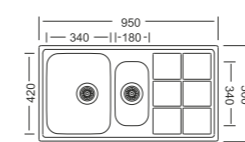

Dimenzija za ugradnju



Širina korpusa

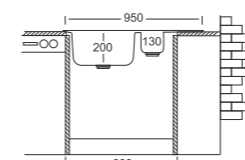

Šifra	Model	Obrada	Dubina korita	Lim deblj.	Slivnik
67.123.01	LTP 950.500/15 GT 8K	polirana	200/130 mm	0.8 mm	3 1/2

Dodatni pribor

808 CR



CS 18.34



B 34.42



SB 32.40



S-805



S-805 P



Instalacione šeme



Ukupne dimenzije

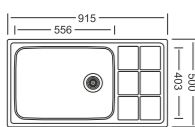

Dimenzija za ugradnju

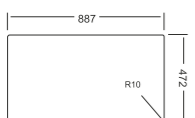

Širina korpusa

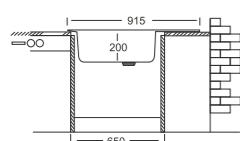

Šifra	Model	Obrada	Dubina korita	Lim deblj.	Slivnik
67.124.01	LTP 915.500/15 GT 8K	polirana	200 mm	0.8 mm	3 1/2

Dodatni pribor

808 CR



B 55.40



S-701 GT



S-701 GTP



S-905 P



S-905



WIND*610.457 GT

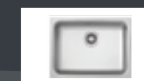

DXT8780 GT



serija Wind >
serija D >



Instalacione šeme



Ukupne dimenzije

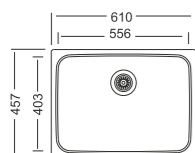

Dimenzija za ugradnju

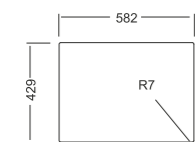

Širina korpusa

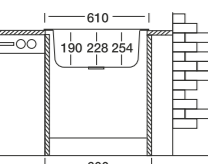

Šifra	Model	Obrada	Dubina korita	Lim deblj.	Slivnik
67.130.01	JMP 610.457 GT 6K	polirana	190 mm	0.6 mm	3 1/2
67.130.02	JMP 610.457 GT 8K	polirana	228 mm	0.8 mm	3 1/2
67.130.03	JMP 610.457 GT 10K	polirana	254 mm	1.0 mm	3 1/2

Dodatni pribor

B 55.40



S-701 GT



S-905 P

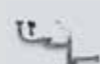

S-905



Instalacione šeme



Ukupne dimenzije

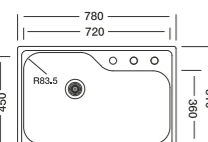

Dimenzija za ugradnju



Širina korpusa

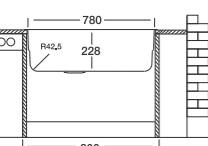

Šifra	Model	Obrada	Dubina korita	Lim deblj.	Slivnik
67.135.01	DXT 780 GT 8K	polirana	228 mm	0.8 mm	3 1/2

Dodatni pribor

808 CR



ORX 610



S-701 GT



S-701 GTP



S-905 P



S-905

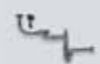

GR*693.503 GW



GR*693.503. 15 GT



serija Grand >

Instalacione šeme



Ukupne dimenzije

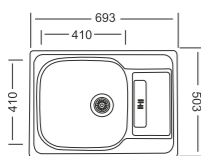

Dimenzija za ugradnju

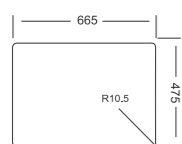

Širina korpusa

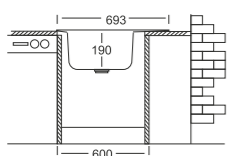

Šifra	Model	Obrada	Dubina korita	Lim deblj.	Slivnik
67.140.01	GRP 693.503 GW 8K	polirana	190 mm	0.8 mm	3 1/2

Dodatni pribor

808 CR



B 41.41



SB 32.40



S-701 GW



S-701 GWP



S-905 P



S-905



Instalacione šeme



Ukupne dimenzije

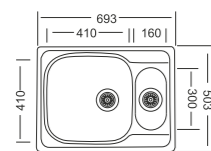

Dimenzija za ugradnju

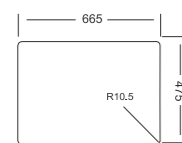

Širina korpusa

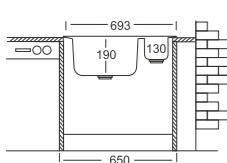

Šifra	Model	Obrada	Dubina korita	Lim deblj.	Slivnik
67.140.02	GRP 693.503 GT 8K	polirana	190/130 mm	0.8 mm	3 1/2

Dodatni pribor

808 CR



CP 16.30



CS 16.30



B 41.41



SB 32.40



S-805



S-805 P



GA*737.488 GT



GA*480.480 GT



serija Galant >

Instalacione šeme



Ukupne dimenzije

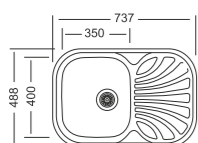

Dimenzija za ugradnju

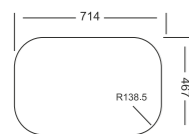

Širina korpusa

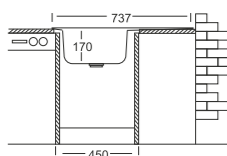

Šifra	Model	Obrada	Dubina korita	Lim deblj.	Slivnik
67.146.01	GAM 737.488 GT 6K	mat	170 mm	0.6 mm	3 1/2
67.146.02	GAL 737.488 GT 6K	linen	170 mm	0.6 mm	3 1/2

Dodatni pribor

808 CR



SBI 32.35



S-701 GT



S-701 GTP



S-905 P



S-905



Instalacione šeme



Ukupne dimenzije

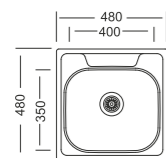

Dimenzija za ugradnju

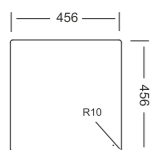

Širina korpusa

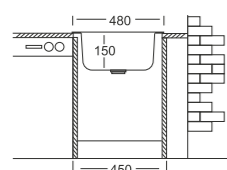

Šifra	Model	Obrada	Dubina korita	Lim deblj.	Slivnik
67.145.01	GAM 480.480 GT 5K	mat	150 mm	0.5 mm	3 1/2

Dodatni pribor

808 CR



B 34.40



SBI 32.35



S-701 GT



S-700 T



S-905 P



S-905



CM*760.435 GT



CL*780.480.20 GT



serija Compact >

Instalacione šeme



Ukupne dimenzije

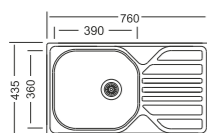

Dimenzija za ugradnju



Širina korpusa

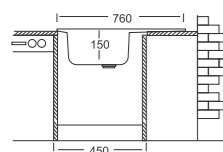

Šifra	Model	Obrada	Dubina korita	Lim deblj.	Slivnik
67.150.01	CMM 760.435 T 5K	mat	150 mm	0.5 mm	1 1/2
67.150.02	CMM 760.435 GT 5K	mat	150 mm	0.5 mm	3 1/2

Dodatni pribor

SBI 32.35



S-700 T



S-701 GT



S-701 GTP



S-905 P



S-905



Instalacione šeme



Ukupne dimenzije

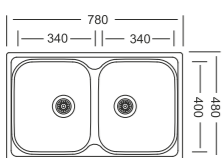

Dimenzija za ugradnju

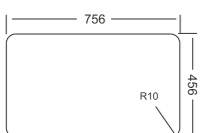

Širina korpusa

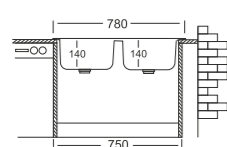

Šifra	Model	Obrada	Dubina korita	Lim deblj.	Slivnik
67.151.01	CLM 780.480/20 GT 6K	mat	140/140 mm	0.6 mm	3 1/2

Dodatni pribor

B 34.40



SB 32.35



S-805



S-805 P



FA*446 GT



FA LOVE*545 GT



FA*490 GT



FA*510 GT



FA*577.447 GT



A*747.447 GT



FA*770.480 GT



FA*780.435 20 GT



serija Favorite >

Instalacione šeme



Ukupne dimenzije



Dimenzija za ugradnju

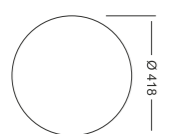

Širina korpusa

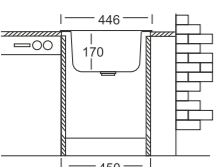

Šifra	Model	Obrada	Dubina korita	Lim deblj.	Slivnik
67.160.01	FAM 446 GT 6K	mat	170 mm	0.6 mm	3 1/2

Dodatni pribor

BR 39



SBR 34



S-700 T



S-701 GT



S-905 P



S-905



Instalacione šeme



Ukupne dimenzije

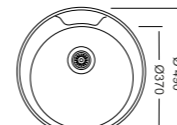

Dimenzija za ugradnju

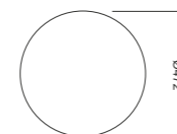

Širina korpusa

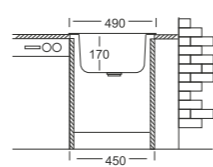

Šifra	Model	Obrada	Dubina korita	Lim deblj.	Slivnik
67.162.01	FAM 490 GT 6K	mat	170 mm	0.6 mm	3 1/2

Dodatni pribor

808 CR



BR 37



SBR 34



S-700 T



S-701 GT



S-905 P



S-905



Instalacione šeme



Ukupne dimenzije

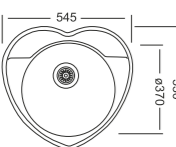

Dimenzija za ugradnju

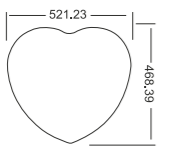

Širina korpusa

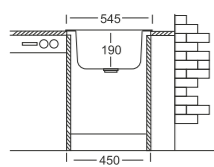

Šifra	Model	Obrada	Dubina korita	Lim deblj.	Slivnik
67.161.01	FA LOVE 545 P GT 8K	polirana	190 mm	0.8mm	3 1/2

Dodatni pribor

808 CR



BR 37



SBR 34



S-701 GT



S-701 GTP



S-905 P



S-905



Instalacione šeme



Ukupne dimenzije

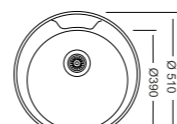

Dimenzija za ugradnju



Širina korpusa

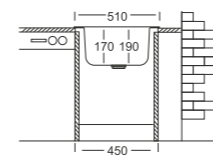

Šifra	Model	Obrada	Dubina korita	Lim deblj.	Slivnik
67.163.01	FAP 510 GT 8K	polirana	190 mm	0.8 mm	3 1/2
67.163.02	FAL 510 GT 6K	linen	170 mm	0.6 mm	3 1/2

Dodatni pribor

808 CR



BR 39



SBR 34



S-700 T



S-701 GT



S-905 P



S-905



Instalacione šeme



Ukupne dimenzije

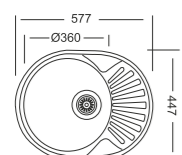

Dimenzija za ugradnju

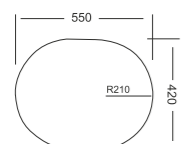

Širina korpusa

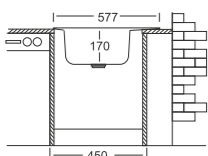

Šifra	Model	Obrada	Dubina korita	Lim deblj.	Slivnik
67.164.01	FAM 577.447 GT 6K	mat	170 mm	0.6 mm	3 1/2

Dodatni pribor

BR 39



SBR 34



S-700 T



S-701 GT



S-701 GTP



S-905 P



S-905



Instalacione šeme



Ukupne dimenzije

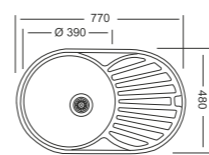

Dimenzija za ugradnju

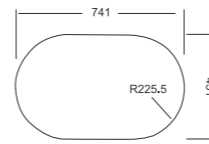

Širina korpusa

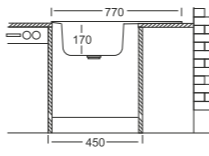

Šifra	Model	Obrada	Dubina korita	Lim deblj.	Slivnik
67.166.01	FAM 770.480 GT 6K	mat	170 mm	0.6 mm	3 1/2
67.166.02	FAL 770.480 GT 6K	linen	170 mm	0.6 mm	3 1/2

Dodatni pribor

BR 39



SBR 34



S-700 T



S-701 GT



S-701 GTP



S-905 P



S-905



Instalacione šeme



Ukupne dimenzije

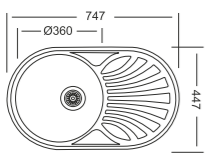

Dimenzija za ugradnju

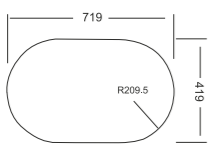

Širina korpusa

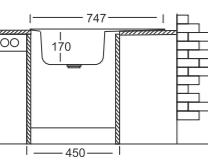

Šifra	Model	Obrada	Dubina korita	Lim deblj.	Slivnik
67.165.01	FAM 747.447 GT 6K	mat	170 mm	0.6 mm	3 1/2

Dodatni pribor

BR 36



SBR 34



S-700 T



S-701 GT



S-701 GTP



S-905 P



S-905



Instalacione šeme



Ukupne dimenzije

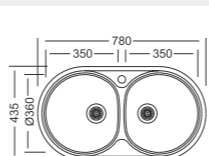

Dimenzija za ugradnju

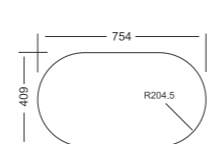

Širina korpusa

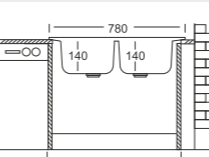

Šifra	Model	Obrada	Dubina korita	Lim deblj.	Slivnik
67.167.01	FAM 780.435/20 GT 6K	mat	140/140 mm	0.6 mm	3 1/2
67.167.02	FAL 780.435/20 GT 6K	linen	140/140 mm	0.6 mm	3 1/2

Dodatni pribor

B 36



SBR 34



S-805



S-805 P





ST*500.600 GT



ST*600.600 GT



ST*800.500 GT



ST*800.600 GT



ST*800.600.20 GT



ST*1000.600 GT



ST*1200.600.20 GT



serija Standard >

Instalacione šeme



Ukupne dimenzije

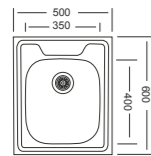

Širina korpusa

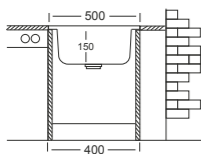

Šifra	Model	Obrada	Dubina korita	Lim deblj.	Slivnik
67.170.01	STM 500.600 GT 5K	mat	150 mm	0.5 mm	1 1/2

Dodatni pribor

SBI 32.35



S-700



S-700 T



S-701 GT



Instalacione šeme



Ukupne dimenzije

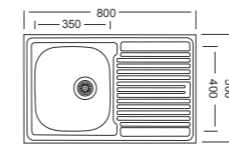

Širina korpusa

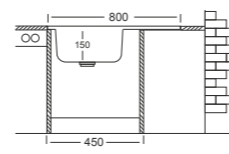

Šifra	Model	Obrada	Dubina korita	Lim deblj.	Slivnik
67.172.01	STM 800.500 GT 5K	mat	150 mm	0.5 mm	1 1/2

Dodatni pribor

SBI 32.35



S-700



S-700 T



S-701 GT



Instalacione šeme



Ukupne dimenzije

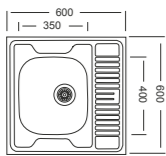

Širina korpusa

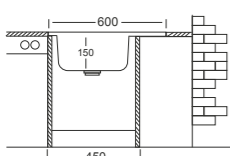

Šifra	Model	Obrada	Dubina korita	Lim deblj.	Slivnik
67.171.01	STM 600.600 GT 5K	mat	150 mm	0.5 mm	1 1/2

Dodatni pribor

SBI 32.35



S-700



S-700 T



S-701 GT



Instalacione šeme



Ukupne dimenzije

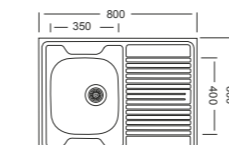

Širina korpusa

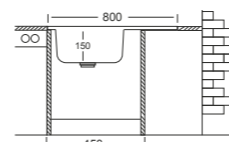

Šifra	Model	Obrada	Dubina korita	Lim deblj.	Slivnik
67.173.01	STM 800.600 GT 5K	mat	150 mm	0.5 mm	1 1/2

Dodatni pribor

SBI 32.35



S-700



S-700 T



S-701 GT



Instalacione šeme



Ukupne dimenzije

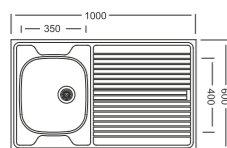

Širina korpusa

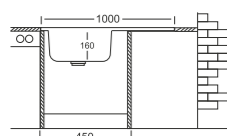

Šifra	Model	Obrada	Dubina korita	Lim deblj.	Slivnik
67.175.01	STM 1000.600 GT 6K	mat	160 mm	0.6 mm	1 1/2

Dodatni pribor

SBI 32.35



S-700



S-700 T



S-701 GT



Instalacione šeme



Ukupne dimenzije

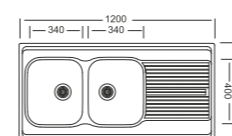

Širina korpusa

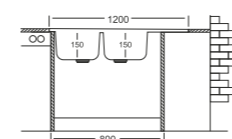

Šifra	Model	Obrada	Dubina korita	Lim deblj.	Slivnik
67.176.01	STM 1200.600/20 GT 6K	mat	150/150 mm	0.6 mm	1 1/2

Dodatni pribor

808 CR



B 34.40



SBI 32.35



S-700 20 GT



S-800 20 GT



S-800 20 GTP



S-805



S-805 P



Instalacione šeme



Ukupne dimenzije

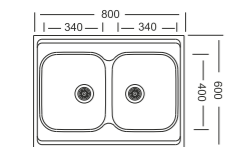

Širina korpusa

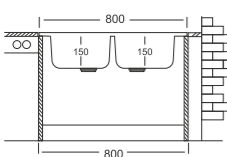

Šifra	Model	Obrada	Dubina korita	Lim deblj.	Slivnik
67.174.01	STM 800.600/20 GT 6K	mat	150/150 mm	0.6 mm	1 1/2

Dodatni pribor

SBI 32.35



S-700 20T



S-800 20 GT



S-805



S-805 P





dodatna oprema >

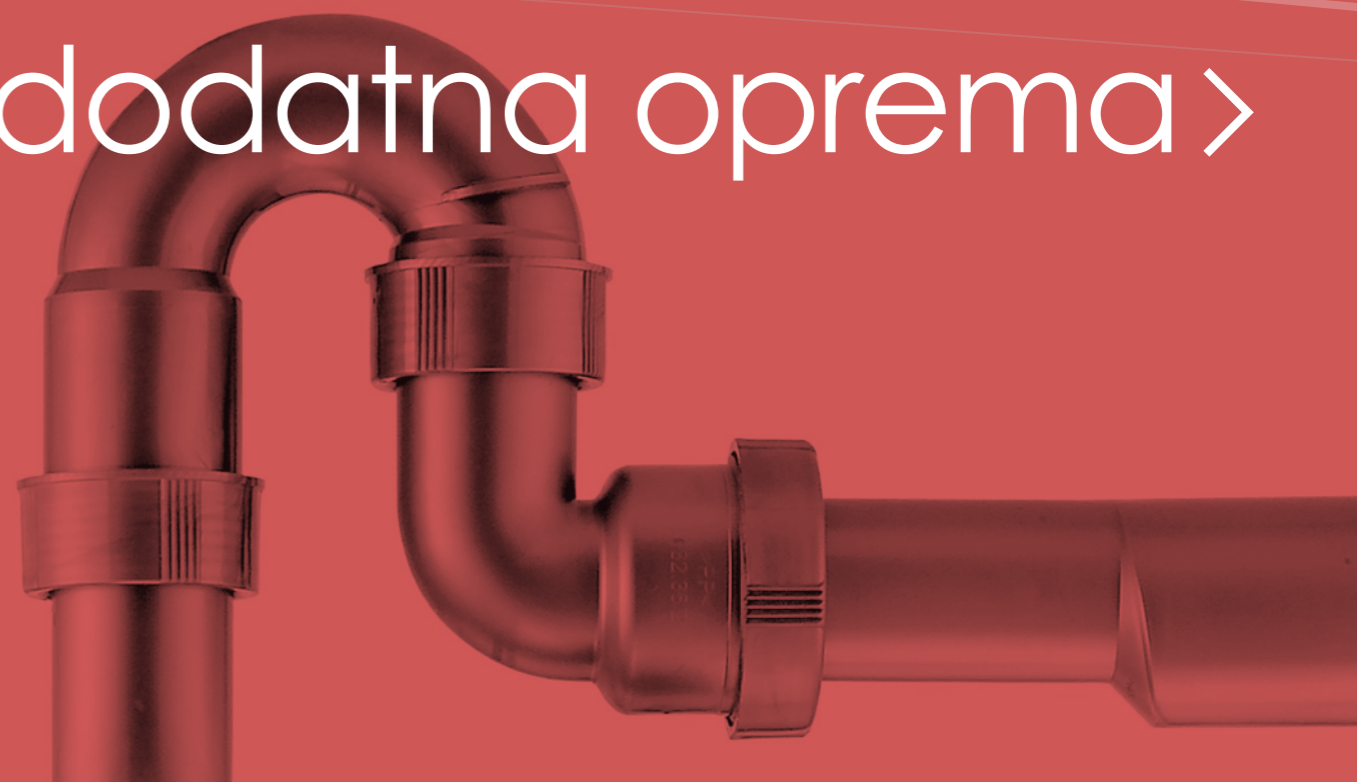

Table za sečenje



B 34.40
B 35.40
B 41.41



B 34.42



GBR 40
BR 36
BR 37
BR 39



ORX 610



B 55.40

Šifra	Model	Obrada
67.210.01	Drvena ploča B34.40	drvo
67.210.02	Drvena ploča B35.40	drvo
67.210.03	Drvena ploča B41.41	drvo
67.210.04	Drvena ploča B34.42	drvo
67.210.05	Drvena ploča GBR 40	drvo
67.210.06	Drvena ploča BR 36	drvo
67.210.07	Drvena ploča BR 37	drvo
67.210.08	Drvena ploča BR 39	drvo
67.210.09	Drvena ploča ORX 610	drvo
67.210.10	Drvena ploča B 55.40	drvo

Dozer deterdženta



808 CR

Šifra	Model	Obrada
67.220.01	Dozer deterdženta 808CR	inox

Ladice za sudopere



CP 16.30



CS 16.30



CS 18.34

Šifra	Model	Obrada
67.230.01	Ladica za sudoperu CP16.30	pvc
67.230.02	Ladica za sudoperu CP16.30	inox
67.230.03	Ladica za sudoperu CP18.34	inox

Žičane korpe za sudopere



SBR 34
ø 340 mm x H 110 mm



SBI 32.35
L 320 x W 350 x H 110 mm



SB 32.40
L 320 x W 400 x H 120 mm

Šifra	Model	Obrada
67.240.01	Žičana korpa za sudoperu SBR34	inox
67.240.02	Žičana korpa za sudoperu SBR32	inox
67.240.03	Žičana korpa za sudoperu SBR32	inox

Sifoni



S-700 T



S-700 W

Šifra	Model
67.200.01	Sifon 1 ½ sa prelivom na koritu S-700 T
67.200.02	Sifon 1 ½ sa prelivom na ocednom delu S-700 W
67.200.03	Sifon 3 ½ sa prelivom na koritu S-700 GT
67.200.04	Sifon 3 ½ sa prelivom na ocednom delu S-700 GW
67.200.05	Sifon 3 ½ sa univerzalnim prelivom S-905 K/GT
67.200.06	Sifon 3 ½ sa univerzalnim prelivom S-805 20 GT



S-701 GW



S-701 GT



S-905



S-805

Ostalo



Šifra	Model
67.250.01	Zaptivni čep za rupu slavine

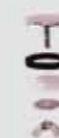

Šifra	Model
67.260.01	Bušač rupe za slavinu fi 35mm



Internacionalni sertifikati:





www.green-line.co.rs

UKINOX

Atatürk Mahallesi Orhan Veli Caddesi No:8
34500 Esenyurt - İstanbul / Turkey

Distributer za Srbiju:

GREEN LINE D.O.O.

ul.Zlatiborska 9, 18000 Niš, Srbija

email: info@green-line.co.rs www.green-line.co.rs

Veleprodaja

ul. Pantelejska 25
18000 Niš, Srbija
tel. +381 18 4285 700
fax. +381 18 4285 701

Izložbeno-prodajni salon

ul. Pantelejska 25
18000 Niš, Srbija
tel. +381 18 4285 702
fax. +381 18 4285 703

Maloprodaja

ul. Pantelejska 17
18000 Niš, Srbija
tel./fax +381 18 4576 896

Maloprodaja "GL centar 2"

35000 Jagodina
18000 Niš, Srbija
tel./fax +381 35 220 382